



**IRF 520/521/522/523/523FI**

SGS-THOMSON

**N - CHANNEL ENHANCEMENT MODE POWER MOS TRANSISTORS**

TYPE	V <sub>DSS</sub>	R <sub>DS(on)</sub>	I <sub>D</sub> <sup>■</sup>
IRF520	100 V	0.27 Ω	9.2 A
IRF520FI	100 V	0.27 Ω	7 A
IRF521	80 V	0.27 Ω	9.2 A
IRF521FI	80 V	0.27 Ω	7 A
IRF522	100 V	0.36 Ω	8 A
IRF522FI	100 V	0.36 Ω	6 A
IRF523	80 V	0.36 Ω	8 A
IRF523FI	80 V	0.36 Ω	6 A

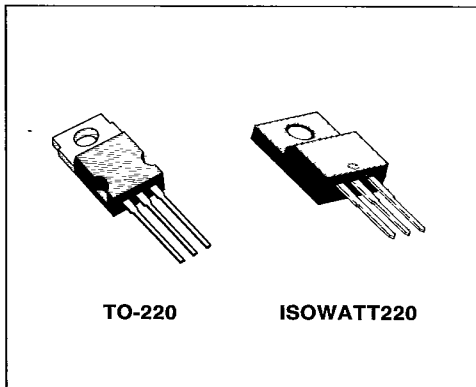

TO-220                      ISOWATT220

- 80-100 VOLTS - FOR DC/DC CONVERTERS
- HIGH CURRENT
- RATED FOR UNCLAMPED INDUCTIVE SWITCHING (ENERGY TEST) ♦
- ULTRA FAST SWITCHING
- EASY DRIVE- FOR REDUCED COST AND SIZE

**INDUSTRIAL APPLICATIONS:**

- UNINTERRUPTIBLE POWER SUPPLIES
- MOTOR CONTROLS

N - channel enhancement mode POWER MOS field effect transistors. Easy drive and very fast switching times make these POWER MOS transistors ideal for high speed switching applications. Applications include DC/DC converters, UPS, battery chargers, secondary regulators, servo control, power-audio amplifiers and robotics.

**INTERNAL SCHEMATIC DIAGRAM**

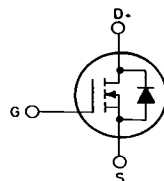

**ABSOLUTE MAXIMUM RATINGS**

		IRF					
		TO-220 ISOWATT220	520 520FI	521 521FI	522 522FI		523 523FI
V <sub>DSS</sub> *	Drain-source voltage (V <sub>GS</sub> = 0)		100	80	100	80	V
V <sub>DGR</sub> *	Drain-gate voltage (R <sub>GS</sub> = 20 KΩ)		100	80	100	80	V
V <sub>GS</sub>	Gate-source voltage		±20				V
I <sub>DM</sub> (*)	Drain current (pulsed)		37	37	32	32	A
I <sub>D</sub>	Drain current (cont.) at T <sub>c</sub> = 25°C		<b>520</b>	<b>521</b>	<b>522</b>	<b>523</b>	A
I <sub>D</sub>	Drain current (cont.) at T <sub>c</sub> = 100°C		9.2	9.2	8	8	A
I <sub>D</sub> <sup>■</sup>	Drain current (cont.) at T <sub>c</sub> = 25°C		6.5	6.5	5.6	5.6	A
I <sub>D</sub> <sup>■</sup>	Drain current (cont.) at T <sub>c</sub> = 100°C		<b>520FI</b>	<b>521FI</b>	<b>522FI</b>	<b>523FI</b>	A
			7	7	6	6	A
			4	4	3.5	3.5	A
P <sub>tot</sub> <sup>■</sup>	Total dissipation at T <sub>c</sub> < 25°C		<b>TO-220</b>		<b>ISOWATT220</b>		W
	Derating factor		60		30		W
T <sub>stg</sub>	Storage temperature		0.48		0.24		W/°C
T <sub>j</sub>	Max. operating junction temperature		-55 to 150				°C
			150				°C

\* T<sub>j</sub> = 25°C to 125°C

(\*) Repetitive Rating: Pulse width limited by max junction temperature.

■ See note on ISOWATT220 on this datasheet.

♦ Introduced in 1988 week 44

30E D ■ 7929237 0029768 5 ■

## THERMAL DATA\*

TO-220 | ISOWATT220

$R_{th(j) - case}$	Thermal resistance junction-case	max	2.08	4.16	°C/W
$R_{th(c-s)}$	Thermal resistance case-sink	typ	0.5		°C/W
$R_{th(j-amb)}$	Thermal resistance junction-ambient	max	80		°C/W
$T_l$	Maximum lead temperature for soldering purpose		300		°C

T-39-11

ELECTRICAL CHARACTERISTICS ( $T_{case} = 25^\circ\text{C}$  unless otherwise specified)

Parameters	Test Conditions	Min.	Typ.	Max.	Unit
------------	-----------------	------	------	------	------

## OFF

$V_{(BR) DSS}$	Drain-source breakdown voltage	$I_D = 250 \mu\text{A}$ for IRF520/522/520FI/522FI for IRF521/523/521FI/523FI	$V_{GS} = 0$	100 80		V V
$I_{DSS}$	Zero gate voltage drain current ( $V_{GS} = 0$ )	$V_{DS} = \text{Max Rating}$ $V_{DS} = \text{Max Rating} \times 0.8$	$T_c = 125^\circ\text{C}$		250 1000	$\mu\text{A}$ $\mu\text{A}$
$I_{GSS}$	Gate-body leakage current ( $V_{DS} = 0$ )	$V_{GS} = \pm 20 \text{ V}$			$\pm 500$	nA

## ON \*\*

$V_{GS(th)}$	Gate threshold voltage	$V_{DS} = V_{GS}$	$I_D = 250 \mu\text{A}$	2		4	V
$I_{D(on)}$	On-state drain current	$V_{DS} > I_{D(on)} \times R_{DS(on) max}$ for IRF520/521/520FI/521FI for IRF521/523/521FI/523FI	$V_{GS} = 10 \text{ V}$	9.2 8			A A
$R_{DS(on)}$	Static drain-source on resistance	$V_{GS} = 10 \text{ V}$ for IRF520/521/520FI/521FI for IRF522/523/522FI/523FI	$I_D = 5.6 \text{ A}$			0.27 0.36	$\Omega$ $\Omega$

## ENERGY TEST

$I_{UIS}$	Unclamped inductive switching current (single pulse)	$V_{DD} = 30 \text{ V}$ starting $T_l = 25^\circ\text{C}$ for IRF520/521/520FI/521FI for IRF522/523/522FI/523FI	$L = 100 \mu\text{H}$	9.2 8			A A
-----------	--	--	-----------------------	----------	--	--	--------

## DYNAMIC

$g_{fs}^{**}$	Forward transconductance	$V_{DS} > I_{D(on)} \times R_{DS(on) max}$ $I_D = 5.6 \text{ A}$		2.7			mho
$C_{iss}$	Input capacitance	$V_{DS} = 25 \text{ V}$	$f = 1 \text{ MHz}$			600	pF
$C_{oss}$	Output capacitance	$V_{GS} = 0$				400	pF
$C_{rss}$	Reverse transfer capacitance					100	pF

ELECTRICAL CHARACTERISTICS (Continued)

Parameters	Test Conditions	Min.	Typ.	Max.	Unit
$t_d$ (on) $t_r$ $t_d$ (off) $t_f$	$V_{DD} = 40\text{ V}$ $I_D = 4.0\text{ A}$ $R_i = 50\ \Omega$ (see test circuit)			40 70 100 70	ns ns ns ns
$Q_g$	Total Gate Charge $V_{GS} = 15\text{ V}$ $V_{DS} = \text{Max Rating} \times 0.8$ (see test circuit)			15	nC

SWITCHING

SOURCE DRAIN DIODE

$I_{SD}$ $I_{SDM}$ (*)	Source-drain current Source-drain current (pulsed)			9.2 37	A A
$V_{SD}^{**}$	Forward on voltage	$I_{SD} = 9.2\text{ A}$	$V_{GS} = 0$	2.5	V
$t_{rr}$ $Q_{rr}$	Reverse recovery time Reverse recovered charge	$T_j = 150^\circ\text{C}$ $I_{SD} = 9.2\text{ A}$	$di/dt = 100\text{ A}/\mu\text{s}$	280 1.6	ns $\mu\text{C}$

\*\* Pulsed: Pulse duration  $\leq 300\ \mu\text{s}$ , duty cycle  $\leq 1.2\%$   
 (\*) Repetitive Rating: Pulse width limited by max junction temperature  
 ■ See note on ISOWATT220 in this datasheet

Safe operating areas (standard package)

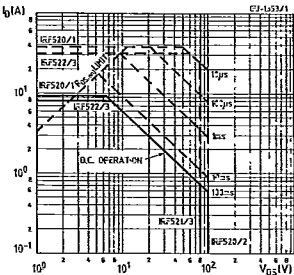

Thermal impedance (standard package)

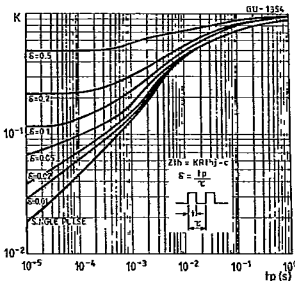

Derating curve (standard package)

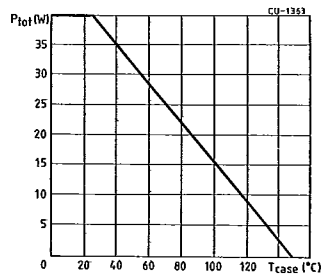

3OE D ■ 7929237 0029770 3 ■

Output characteristics

Output characteristics

Transfer characteristics

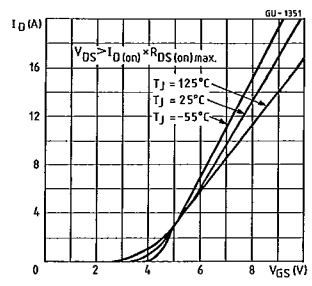
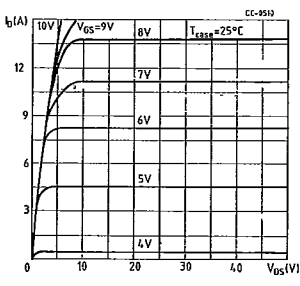
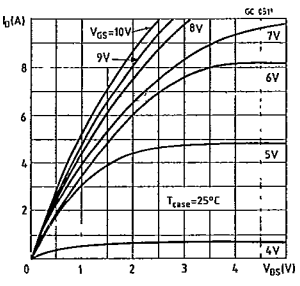

Transconductance

Static drain-source on resistance

Maximum drain current vs temperature

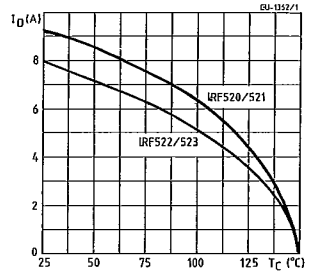
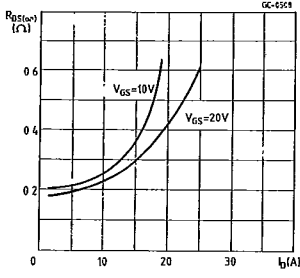
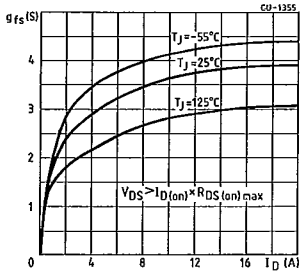

Gate charge vs gate-source voltage

Capacitance variation

Normalized breakdown voltage vs temperature

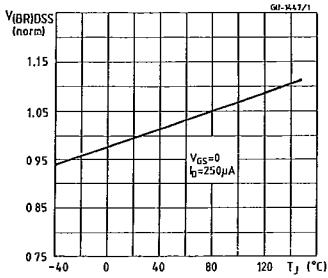
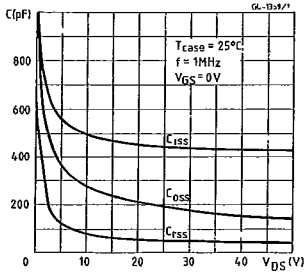
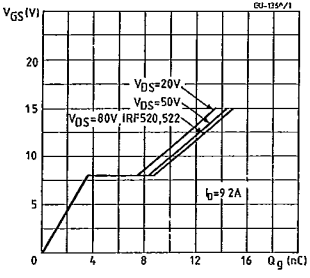

3QE D 7929237 0029771 5

T-39-11

Normalized on resistance vs temperature

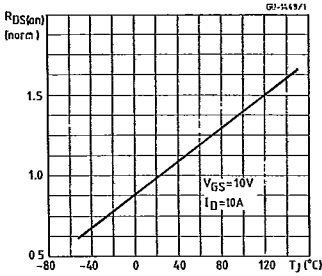

Source-drain diode forward characteristics

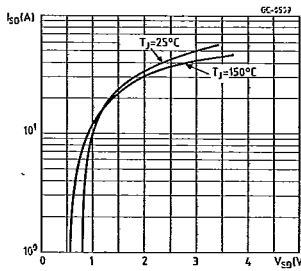

Unclamped inductive test circuit

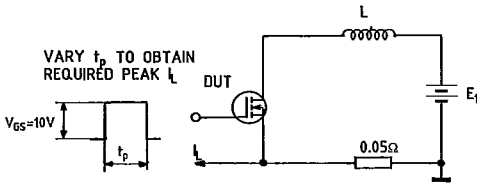

SC-0339

Unclamped inductive waveforms

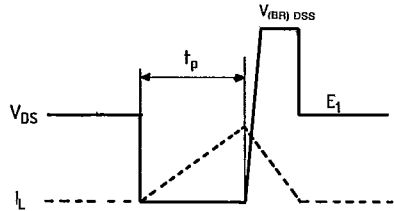

SC-0338

Switching times test circuit

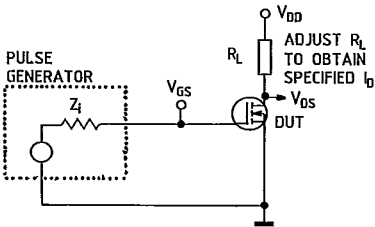

SC-0246

Gate charge test circuit

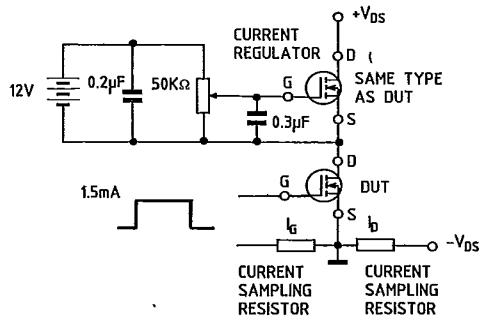

SC-0244

**ISOWATT220 PACKAGE CHARACTERISTICS AND APPLICATION.**

ISOWATT220 is fully isolated to 2000V dc. Its thermal impedance, given in the data sheet, is optimised to give efficient thermal conduction together with excellent electrical isolation.

The structure of the case ensures optimum distances between the pins and heatsink. The ISOWATT220 package eliminates the need for external isolation so reducing fixing hardware. Accurate moulding techniques used in manufacture assure consistent heat spreader-to-heatsink capacitance.

ISOWATT220 thermal performance is better than that of the standard part, mounted with a 0.1mm mica washer. The thermally conductive plastic has a higher breakdown rating and is less fragile than mica or plastic sheets. Power derating for ISOWATT220 packages is determined by:

$$P_D = \frac{T_j - T_c}{R_{th}}$$

from this  $I_{Dmax}$  for the POWER MOS can be calculated:

$$I_{Dmax} \leq \sqrt{\frac{P_D}{R_{DS(on)} \text{ (at } 150^\circ\text{C)}}}$$

**THERMAL IMPEDANCE OF ISOWATT220 PACKAGE**

Fig. 1 illustrates the elements contributing to the thermal resistance of transistor heatsink assembly, using ISOWATT220 package.

The total thermal resistance  $R_{th (tot)}$  is the sum of each of these elements.

The transient thermal impedance,  $Z_{th}$  for different pulse durations can be estimated as follows:

1 - for a short duration power pulse less than 1ms;

$$Z_{th} < R_{thJ-C}$$

2 - for an intermediate power pulse of 5ms to 50ms:

$$Z_{th} = R_{thJ-C}$$

3 - for long power pulses of the order of 500ms or greater:

$$Z_{th} = R_{thJ-C} + R_{thC-HS} + R_{thHS-amb}$$

It is often possible to discern these areas on transient thermal impedance curves.

Fig. 1

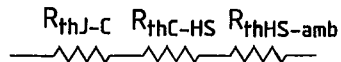

**ISOWATT DATA**

Safe operating areas

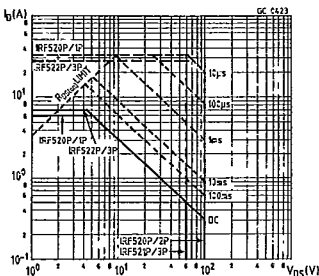

Thermal impedance

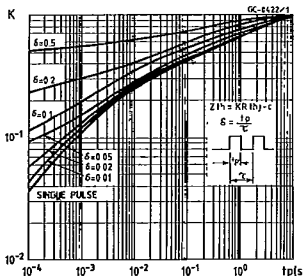

Derating curve

