

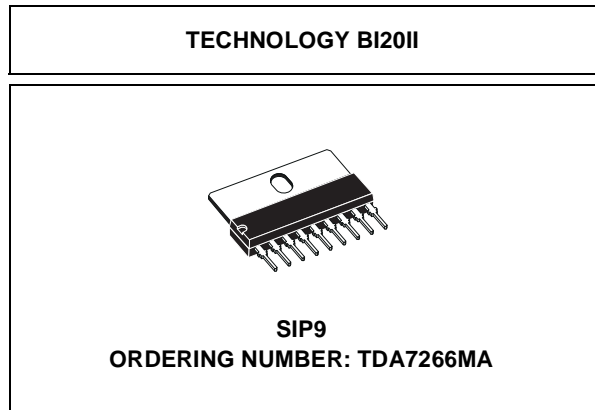

TDA7266MA

7W MONO BRIDGE AMPLIFIER

- WIDE SUPPLY VOLTAGE RANGE (3-18V)
- MINIMUM EXTERNAL COMPONENTS
 - NO SWR CAPACITOR
 - NO BOOTSTRAP
 - NO BOUCHEROT CELLS
 - INTERNALLY FIXED GAIN
- STAND-BY & MUTE FUNCTIONS
- SHORT CIRCUIT PROTECTION
- THERMAL OVERLOAD PROTECTION



DESCRIPTION

The TDA7266MA is a mono bridge amplifier specially designed for TV and Portable Radio applications.

Pin to pin compatible with: TDA7266S, TDA7266, TDA7266M, TDA7266MA, TDA7266B, TDA7297SA & TDA7297.

Figure 1. Block and Application Diagram

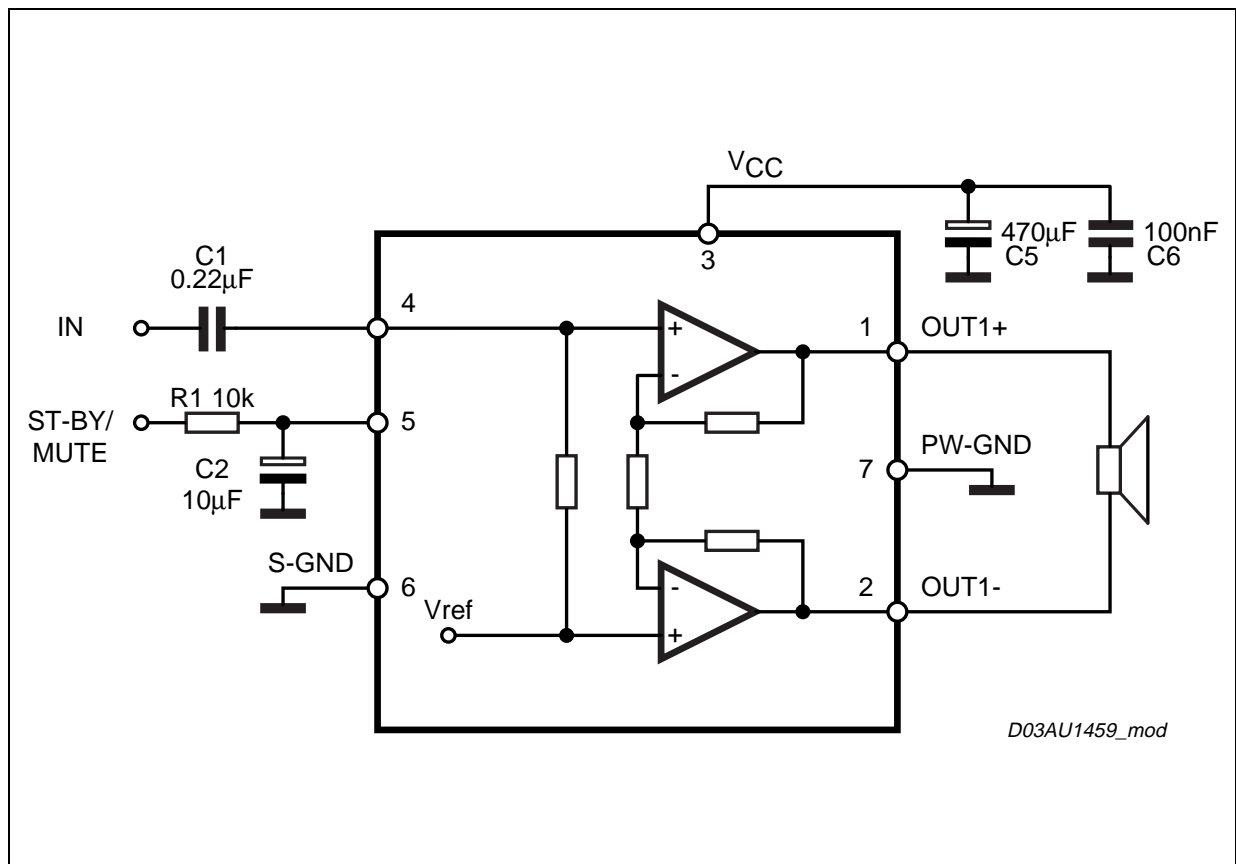

TDA7266MA

ABSOLUTE MAXIMUM RATINGS

Symbol	Parameter	Value	Unit
V_s	Supply Voltage	20	V
I_O	Output Peak Current (internally limited)	2	A
T_{op}	Operating Temperature	0 to 70	°C
T_{stg}, T_j	Storage and Junction Temperature	-40 to 150	°C

THERMAL DATA

Symbol	Parameter	Value	Unit
$R_{th\ j-case}$	Thermal Resistance Junction-case	9	°C/W

PIN CONNECTION (Top view)

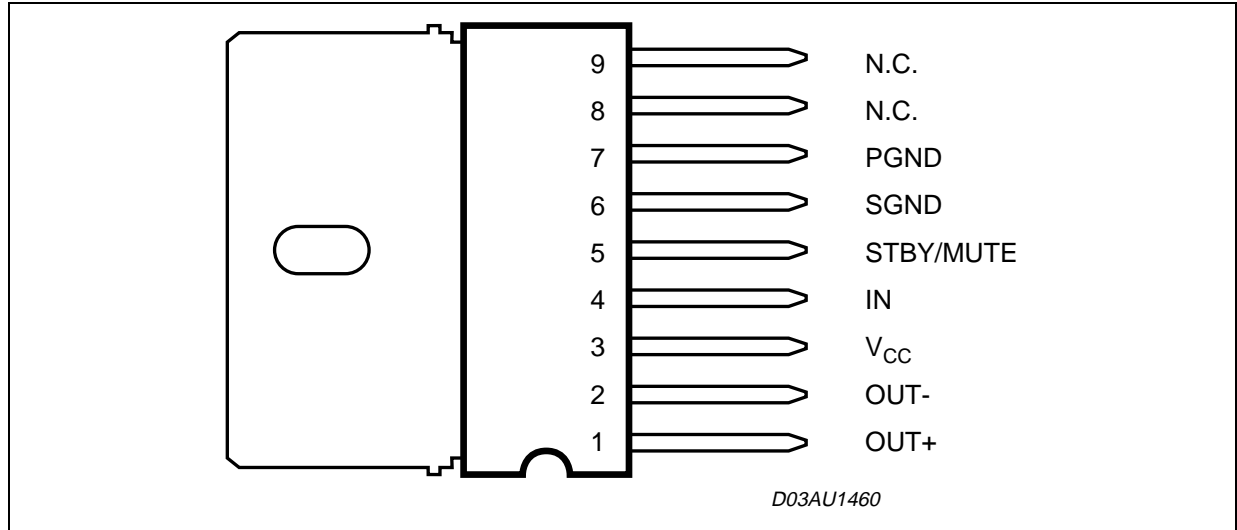

ELECTRICAL CHARACTERISTICS

($V_{CC} = 11V$, $R_L = 8\Omega$, $f = 1KHz$, $T_{amb} = 25^\circ C$ unless otherwise specified)

Symbol	Parameter	Test Condition	Min.	Typ.	Max.	Unit
V_{CC}	Supply Range		3	11	18	V
I_q	Total Quiescent Current			50	65	mA
V_{OS}	Output Offset Voltage				120	mV
P_O	Output Power	THD 10%	6.3	7		W
THD	Total Harmonic Distortion	$P_O = 1W$		0.05	0.2	%
		$P_O = 0.1W$ to $2W$ $f = 100Hz$ to $15KHz$			1	%
SVR	Supply Voltage Rejection	$f = 100Hz$, $V_R = 0.5V$	40	56		dB
A_{MUTE}	Mute Attenuation		60	80		dB
T_w	Thermal Threshold			150		°C
G_V	Closed Loop Voltage Gain		25	26	27	dB
R_i	Input Resistance		25	30		K Ω

ELECTRICAL CHARACTERISTICS (continued)(V_{CC} = 11V, R_L = 8Ω, f = 1KHz, T_{amb} = 25°C unless otherwise specified)

Symbol	Parameter	Test Condition	Min.	Typ.	Max.	Unit
VT _{MUTE}	Mute Threshold	for V _{CC} > 6.4V; Vo = -30dB	2.3	2.9	4.1	V
		for V _{CC} < 6.4V; Vo = -30dB	V _{CC} /2 -1	V _{CC} /2 -075	V _{CC} /2 -0.5	V
VT _{ST-BY}	St-by Threshold		0.8	1.3	1.8	V
I _{ST-BY}	St-by Current V6 = GND				100	μA
e _N	Total Output Voltage	A Curve; f = 20Hzto 20KHz		150		μV

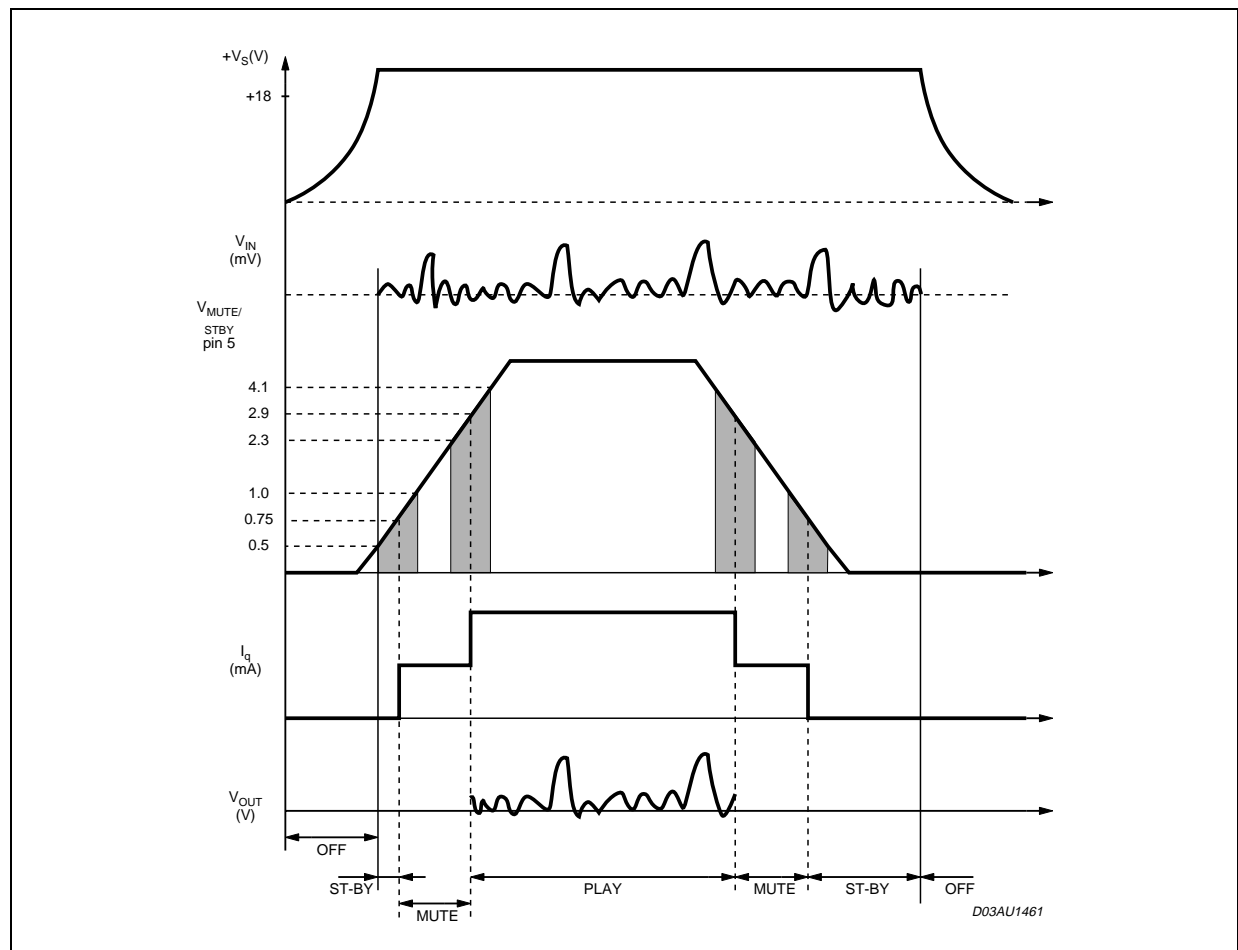
APPLICATION SUGGESTION**STAND-BY AND MUTE FUNCTIONS****Figure 2. Microprocessor Driving Signals**

The St-by and mute terminals are tied together and they are connected to the supply line via an external voltage divider.

The device is switched-on/off from the supply line and the external capacitor C4 is intended to delay the St-by and mute threshold exceeding, avoiding "Popping" problems.

Figure 3. Stand-alone low-cost Application

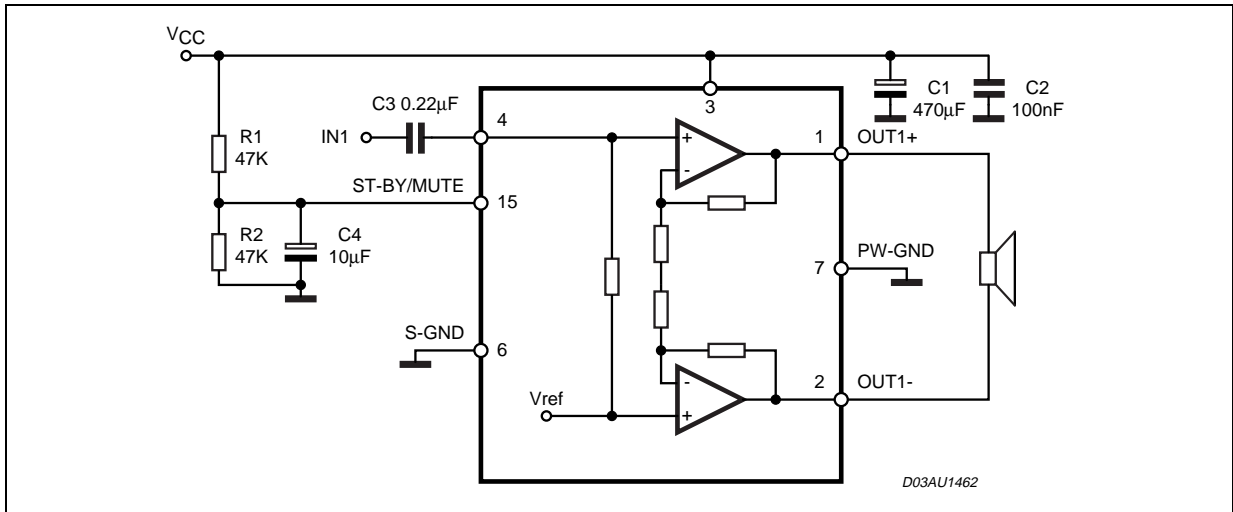

Figure 4. Distortion vs Ouput Power

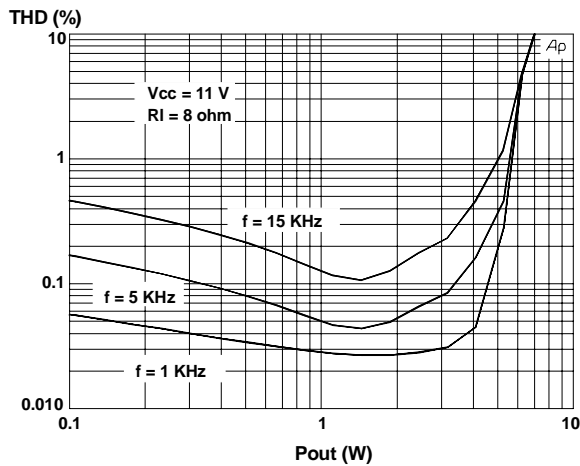

Figure 6. Distortion vs. Frequency

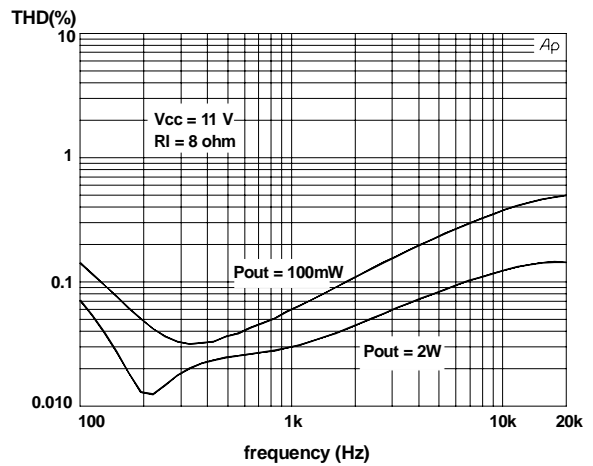

Figure 5. Distortion vs Ouput Power

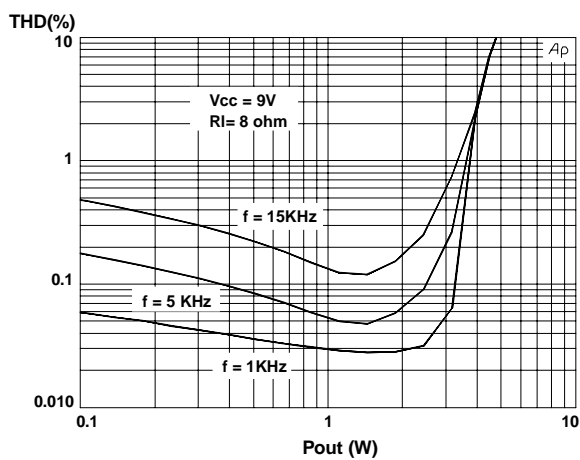

Figure 7. Gain vs Frequency

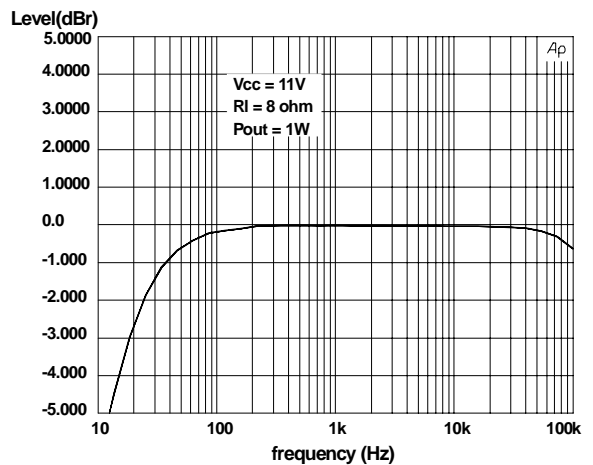

Figure 8. Output Power vs. Supply Voltage

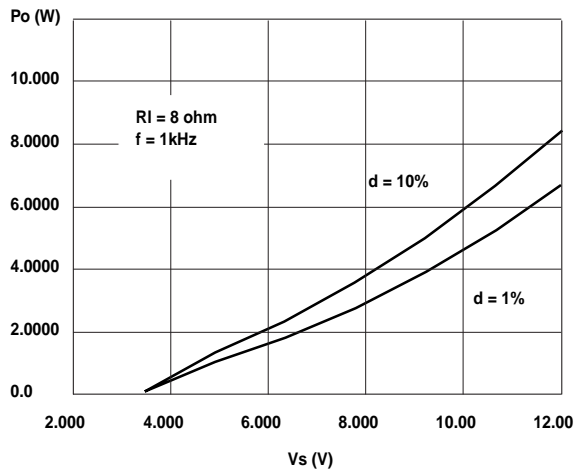

Figure 10. Mute & Stand-By Attenuation vs. $V_{pin.5}$

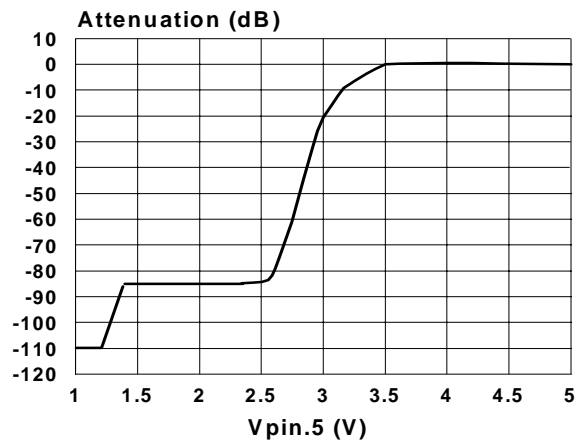

Figure 9. P_{tot} Dissipation & Efficiency vs. P_{out}

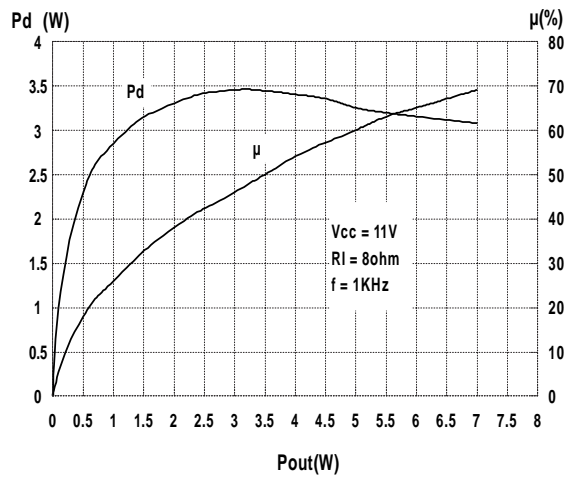

Figure 11. Quiescent Current vs. Supply Voltage

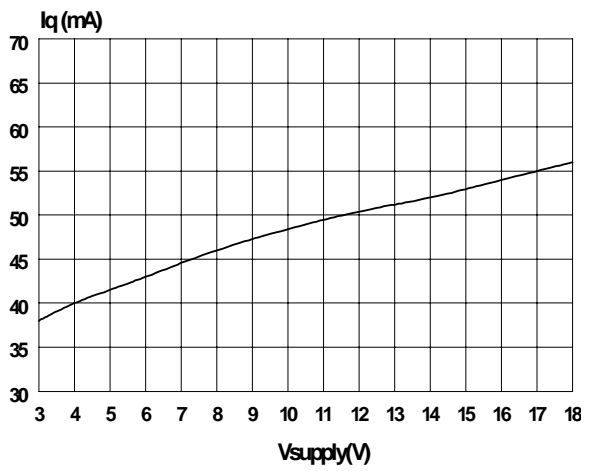

Figure 12. PC Board Component Layout

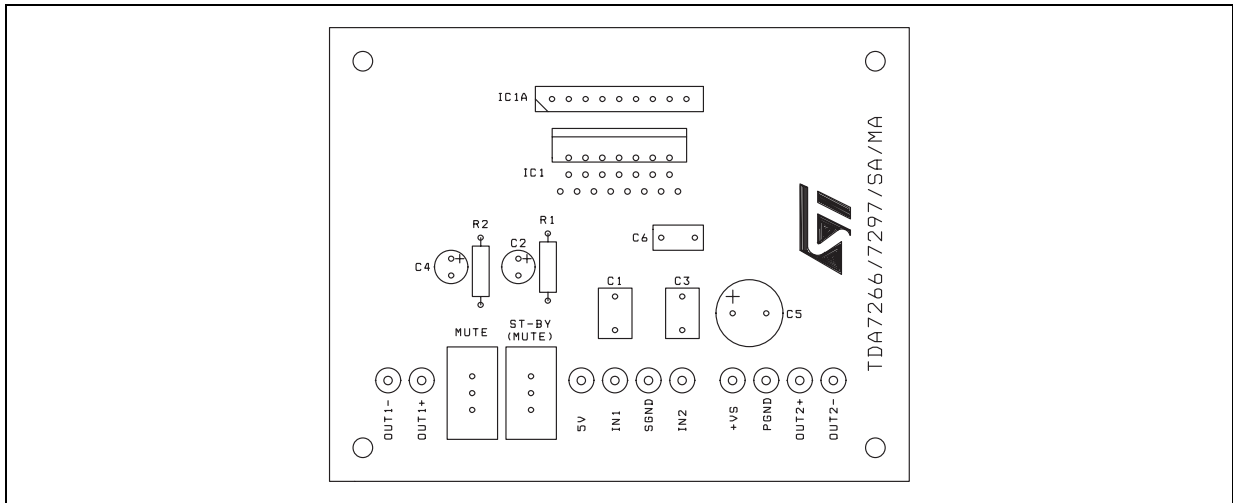

Figure 13. Evaluation Board Top Layer Layout

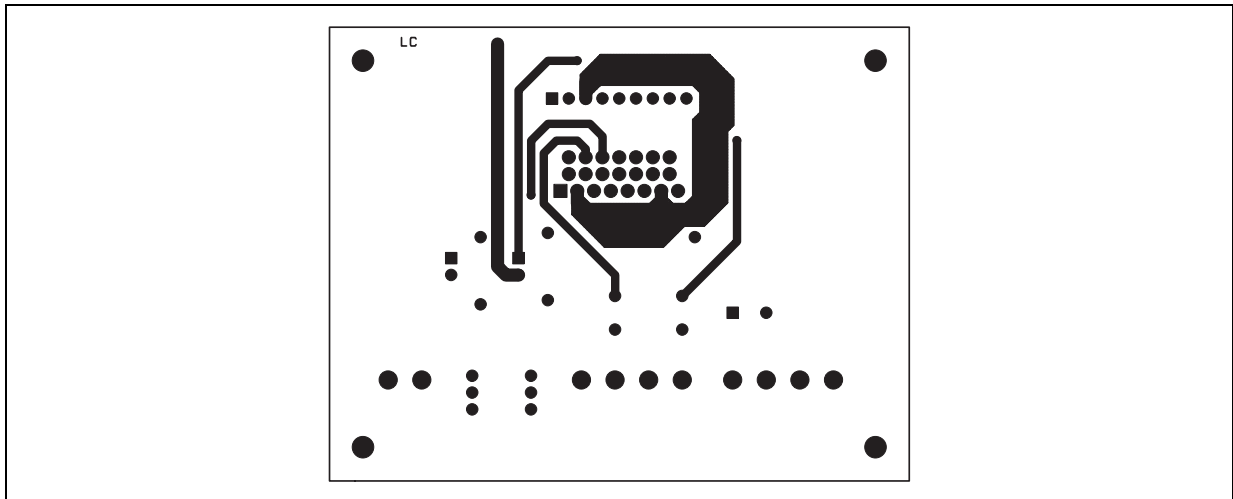
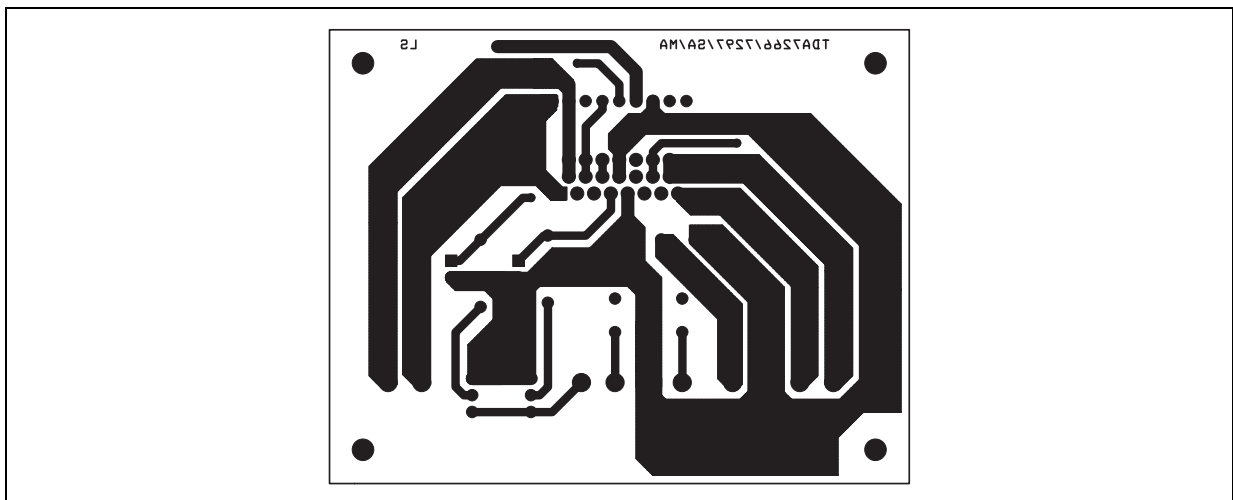

Figure 14. Evaluation Board Bottom Layer Layout



HEAT SINK DIMENSIONING:

In order to avoid the thermal protection intervention, that is placed approximatively at $T_j = 150^\circ\text{C}$, it is important the dimensioning of the Heat Sink R_{Th} ($^\circ\text{C}/\text{W}$).

The parameters that influence the dimensioning are:

- Maximum dissipated power for the device (P_{dmax})
- Max thermal resistance Junction to case ($R_{Th\ j-c}$)
- Max. ambient temperature $T_{amb\ max}$
- Quiescent current I_q (mA)

Example:

$V_{CC} = 11\text{V}$, $R_{load} = 80\text{ohm}$, $R_{Th\ j-c} = 9\ ^\circ\text{C}/\text{W}$, $T_{amb\ max} = 50^\circ\text{C}$

$$P_{dmax} = (N^\circ \text{ channels}) \cdot \frac{V_{CC}^2}{\Pi^2 \cdot \frac{R_{load}}{2}} + I_q \cdot V_{CC}$$

$$P_{dmax} = 1 \cdot (3) + 0.5 = 3.5\text{W}$$

$$(\text{Heat Sink}) R_{Th\ c-a} = \frac{150 - T_{amb\ max}}{P_{d\ max}} - R_{Th\ j-c} = \frac{150 - 50}{3.5} - 9 = 19.5^\circ\text{C}/\text{W}$$

In figure 15 is shown the Power derating curve for the device.

Figure 15. Power derating curve

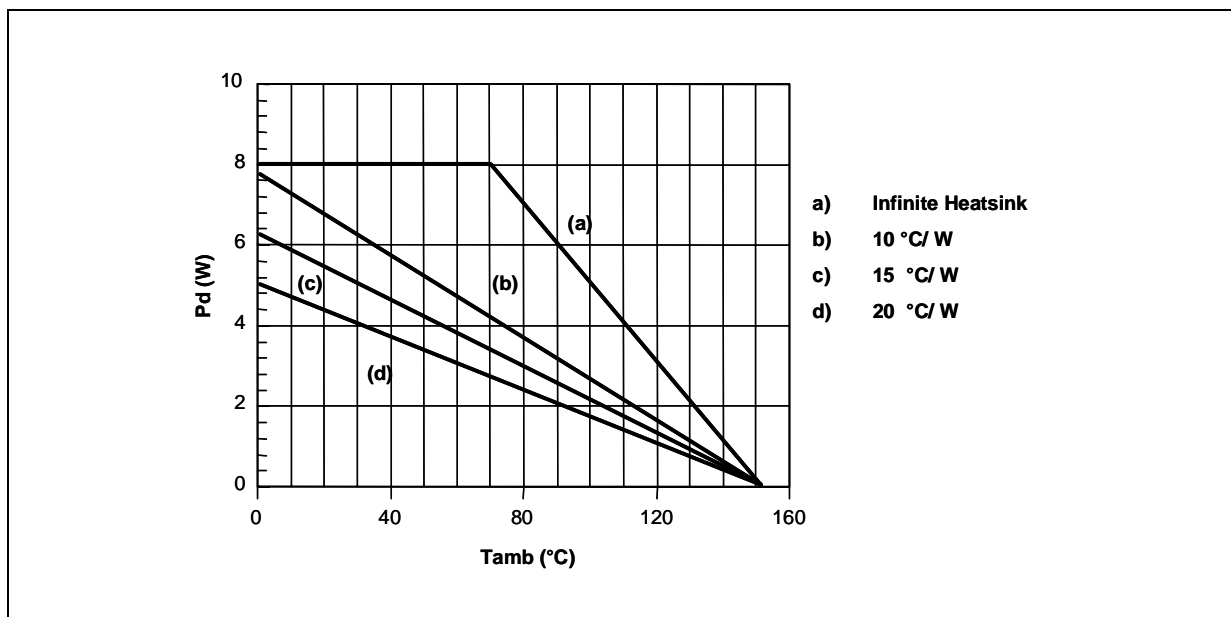

Information furnished is believed to be accurate and reliable. However, STMicroelectronics assumes no responsibility for the consequences of use of such information nor for any infringement of patents or other rights of third parties which may result from its use. No license is granted by implication or otherwise under any patent or patent rights of STMicroelectronics. Specifications mentioned in this publication are subject to change without notice. This publication supersedes and replaces all information previously supplied. STMicroelectronics products are not authorized for use as critical components in life support devices or systems without express written approval of STMicroelectronics.

The ST logo is a registered trademark of STMicroelectronics
© 2003 STMicroelectronics - All Rights Reserved

Australia - Brazil - Canada - China - Finland - France - Germany - Hong Kong - India - Israel - Italy - Japan - Malaysia - Malta - Morocco -
Singapore - Spain - Sweden - Switzerland - United Kingdom - United States.
<http://www.st.com>