

DD231

Version : A.001
Issue Date : 2004/6/1
File Name : SP-DD231-A.001.doc
Total Pages: 7

3-CHANNEL CONSTANT CURRENT LED DRIVERS



新竹市科學園區展業一路9號7樓之1
SILICON TOUCH TECHNOLOGY INC.
9-7F-1, Prosperity Road I, Science Based Industrial Park,
Hsin-Chu, Taiwan 300, R.O.C.
Tel : 886-3-5645656 Fax : 886-3-5645626

DD231

3-CHANNEL CONSTANT CURRENT LED DRIVERS

DESCRIPTION

The DD231 is a 3-channel constant current LED driver. It's designed to operate as a constant-current sink to drive the LEDs with an external resistance in low power environment. Because the DD231 directly determines output current by each channel in low Bit-to-Bit skew, it is ideal for driving LED whose light intensity is proportional to the current passing through them, not the voltage across their terminals.

This configuration eliminates the need of external capacitors and inductances. With an input voltage range of 3V to 5V, so the device can work in general battery system. The value of constant current can be varied using an external resistor ($I_{out} = 5 \sim 30\text{mA}$).

GENERAL FEATURES

- Constant Current Output, 5~30mA.
- Supply Voltage VDD is 3V to 5V.
- Bit-to-Bit : $\pm 3.0\%$ (Max) @ $I_{OUT} = 5 \sim 30\text{mA}$.
- Only Need One External Resistor, No Other External Parts.
- Small 6-Pin SOT26 Package.

APPLICATIONS

- White LED Display Backlighting
- Cellular Telephones
- Handheld Computers
- Digital Cameras
- Portable MP3 Players
- Pagers
- Personal Digital Assistant
- E-Books and Sub Notebooks

Pin Description

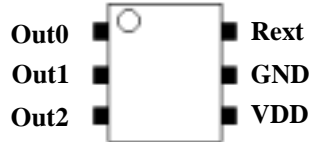

PIN NAME	DESCRIPTION
VDD	Power supply terminal
Rext	Input terminal of an external resistor
GND	Ground terminal
Out0 to Out2	Output terminal

Maximum Ratings (Ta = 25°C, Tj(max) = 140°C)

CHARACTERISTIC	SYMBOL	RATING	UNIT
Supply Voltage	VDD	7	V
Output Current	IOUT	30	mA
Output Voltage	VOUT	~17	V
GND Terminal Current	IGND	90	mA
Power Dissipation	PD	0.35	W
Operating Temperature	Top	-20 ~ 85	°C
Storage Temperature	Tstg	-55 ~ 150	°C

Recommended Operating Condition

CHARACTERISTIC	SYMBOL	CONDITION	MIN.	TYP.	MAX.	UNIT
Supply Voltage	VDD	—	2.7	3.3	6	V
Output Voltage	VOUT	—	0.2	0.6	5.0	V
Output Current	IO	Outn	5	—	30	mA
Operating temperature	T _{OPR}	—	-20	—	85	°C

Electrical Characteristics (Typ:VDD = 3.3 V, Ta = 25°C unless otherwise noted)

CHARACTERISTIC	SYMBOL	CONDITION	MIN.	TYP.	MAX.	UNIT
Output Current (Bit-Bit)	IOL1	VOUT = 1 V REXT = 12kΩ	—	±1.5	±3	%
	IOL2	VOUT = 0.5 REXT = 60kΩ	—	±1.5	±3	%
Output Current (Chip-Chip)	IOL3	VOUT = 1.0V, REXT = 12kΩ	26.3	29.2	32.1	mA
	IOL4	VOUT = 0.5V, REXT = 60kΩ	4.8	5.31	5.8	mA

Detailed Description

1) Constant Current Output Value Setting

The output current is determined by the resistance connected between REXT pin and GND. The approximate relation between the resistance value and the base current value is shown in Fig1, the approximate equation presented in (Eq.1).

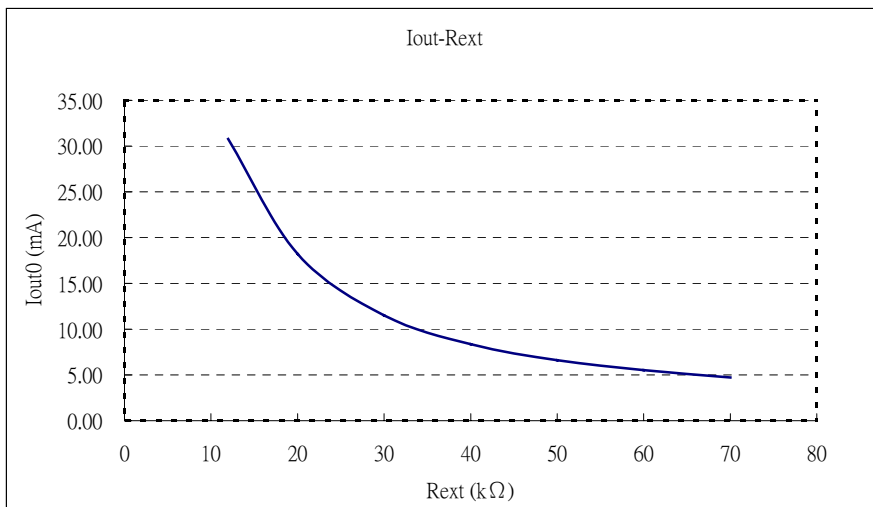

Fig 1

$$I_{out} \cong 350.4/R_{ext} \quad (\text{Eq.1})$$

2) Constant Current Output Value and Output Voltage

In order to obtain a good constant current output, a suitable output voltage is necessary. Users can get related information about the minimum output voltage from Fig 2.

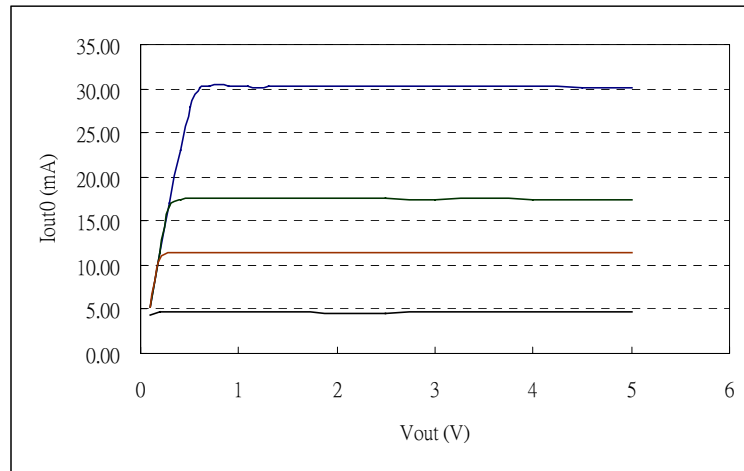

Fig 2

TYPICAL APPLICATION

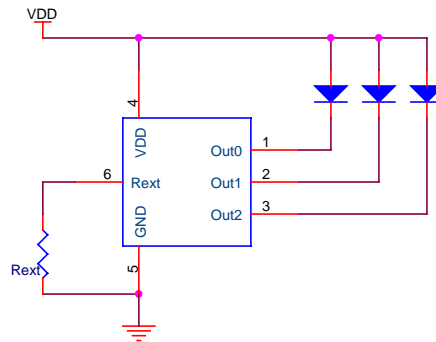
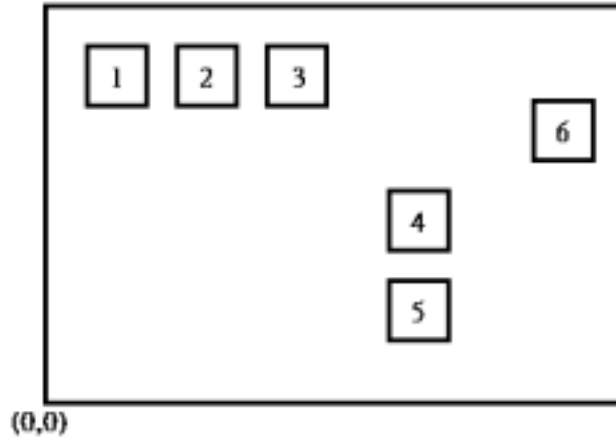

Fig 3

DIE CONFIGURATION (UNIT: μ M)



Die Size: 984.3X643.8

Die Thickness: 300

Pad Size: 80X80

Pin NO.	PAD Name	Center Coordinate (X,Y)	
1	Out0	80.5	564.1
2	Out1	202.1	564.1
3	Out2	323.7	564.1
4	Rext	581.3	391.5
5	GND	586.5	224.9
6	VDD	913.9	419.25

Package Outline (SOT26)

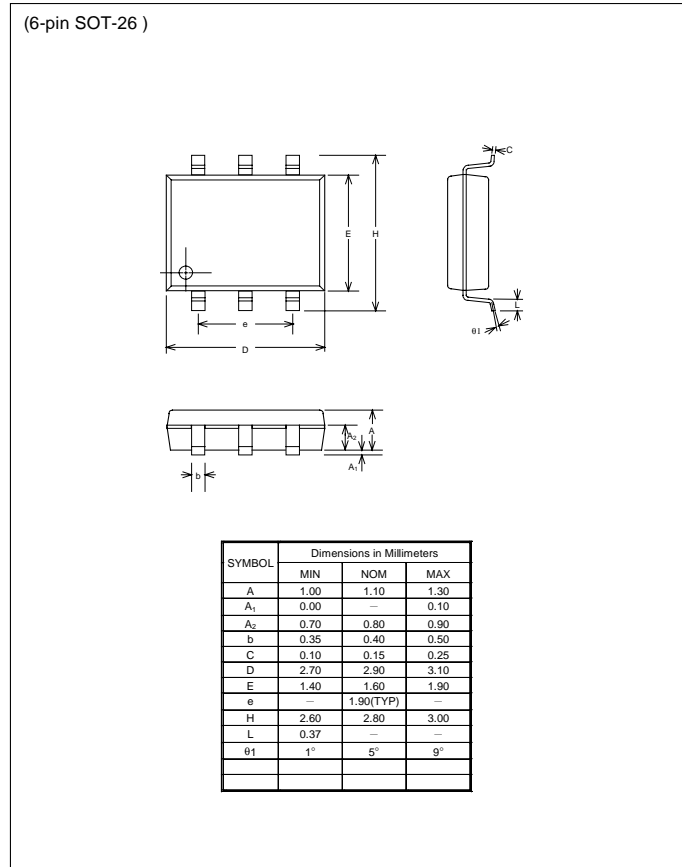

The products listed herein are designed for ordinary electronic applications, such as electrical appliances, audio-visual equipment, communications devices and so on. Hence, it is advisable that the devices should not be used in medical instruments, surgical implants, aerospace machinery, nuclear power control systems, disaster/crime-prevention equipment and the like. Misusing those products may directly or indirectly endanger human life, or cause injury and property loss.

Silicon Touch Technology, Inc. will not take any responsibilities regarding the misuse of the products mentioned above. Anyone who purchases any products described herein with the above-mentioned intention or with such misused applications should accept full responsibility and indemnify. Silicon Touch Technology, Inc. and its distributors and all their officers and employees shall defend jointly and severally against any and all claims and litigation and all damages, cost and expenses associated with such intention and manipulation.